

StarBoard FX-DUO/FX-TRIO
Wireless Connection Setup Manual

(Windows XP SP3)

1. Preface	2
2. Device Server SX-2000WG+ Setup	3
3. Planex GW-USMicro300 Detailed Setup	13
4. FX-DUO/FX-TRIO Setup	21
5. How to reconnect	23
6. Trouble Shooting	24

1. Preface

To establish the wireless connection between StarBoard FX-DUO/FX-TRIO and the PC, the following devices are necessary:

StarBoard:	FX-DUO 63/77/88W FX-TRIO 77/77S/88W
Wireless USB Device Server:	Silex technology SX-2000WG+
USB2.0 WiFi Adapter:	Planex GW-USMicro300

StarBoard Software 9.3 or later is necessary prior to setup of the wireless connection. Make sure to select "**FX-DUO/FX-TRIO**" in the **Board Type** screen during the installation of StarBoard Software.

Installation of GW-USMicro300 driver

- Log on as Administrator to install.
- Do not plug the USB2.0 WiFi Adapter into the computer until 3(10).
- Disable the firewall on Windows XP and commercial security software during installation.

Caution

- If you execute "LsCamWiz" or "LTabMonA" in "FX-DUODriver"(*1) folder after this setup, be sure to connect the PC and FX-DUO/FX-TRIO directory by USB cable and execute them.
※ "LsCamWiz" or "LTabMonA" execution during wireless connection is not supported.
- (*1) "C Drive" → "Program Files" → "Hitachi Software Engineering" → "FX-DUODriver"
(*)This folder path may be changed since it depends on your Windows installation.

Copyright of captured images of "Device Server Setup" and "SX Virtual Link application" in this document are reserved to Silex Technology, Inc.

Copyright of captured images of "Wireless Utility" in this document are reserved to PLANEX COMMUNICATIONS INC.

Windows is a trademark of Microsoft Corporation (U.S.) and in other countries.

2. Device Server SX-2000WG+ Setup

(1) Connect the SX-2000WG+ and PC with one of the following methods:

(a) Prepare a network cross over cable to connect SX-2000WG+ and PC

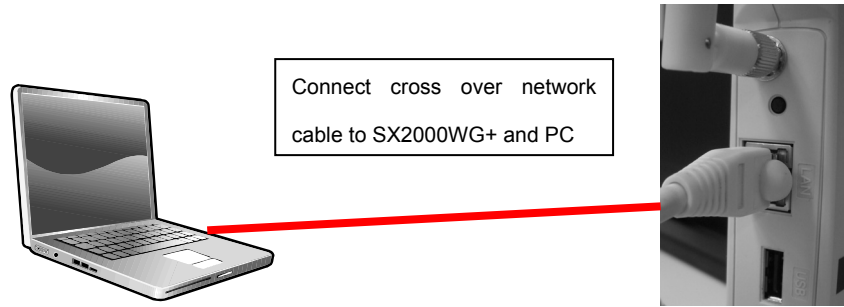

(b) Prepare two network straight cables and an Ethernet hub to connect SX-2000WG+ and PC

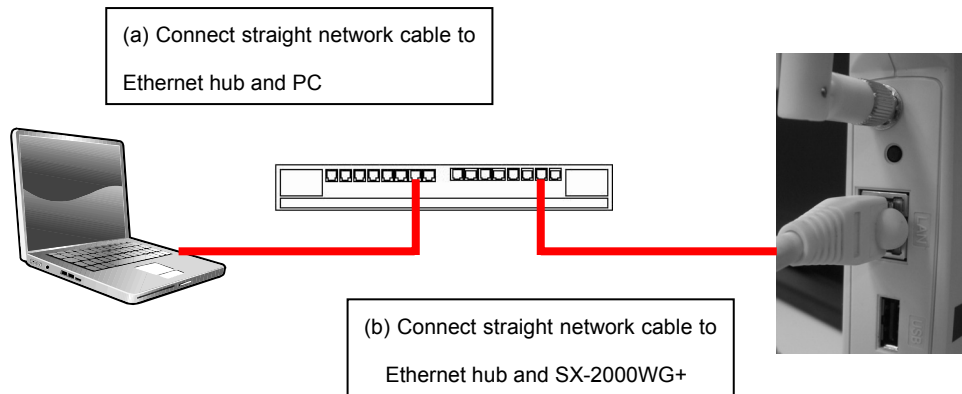

(2) Reset SX-2000WG+ as shown below.

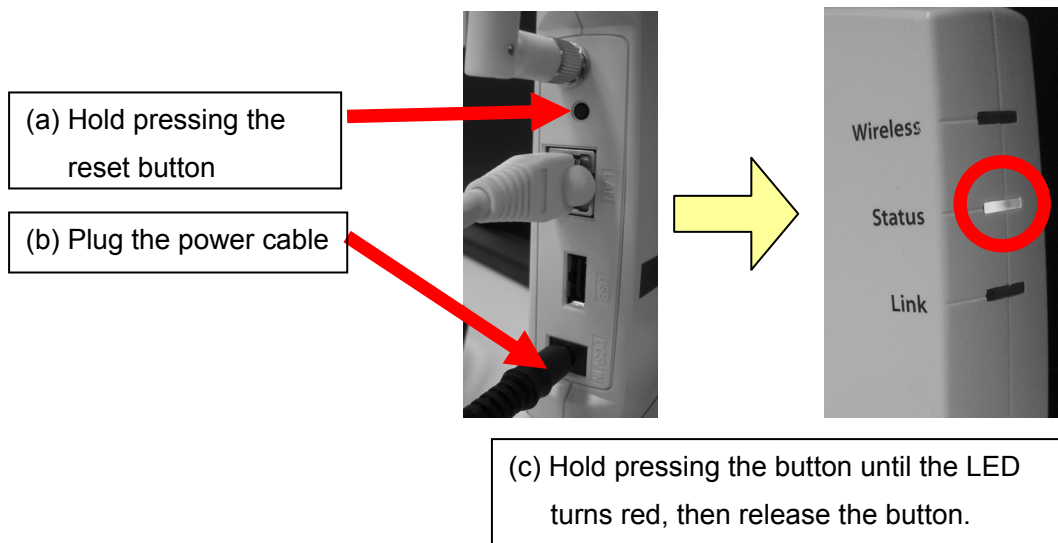

(3) And then, make sure the bottom LED is solid green.



If the LED shows wireless

If the LED is blinking green (wireless connection) as shown below, follow (a)-(c) in the section 2(2)



If still not good, refer to Trouble shooting 6(1)

(4) Download the file "20110401 Silex_WIN.zip" from software download site of Hitachi Solutions America, Ltd. (<http://www.hitachisolutions-us.com/>).

(5) Unzip "20110401 Silex_WIN.zip".

(6) Move to "silex" folder and run "Autorun".

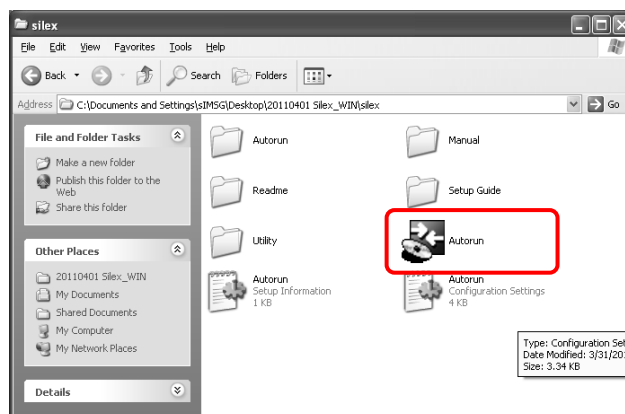

(7) Select "Device Server Setup".

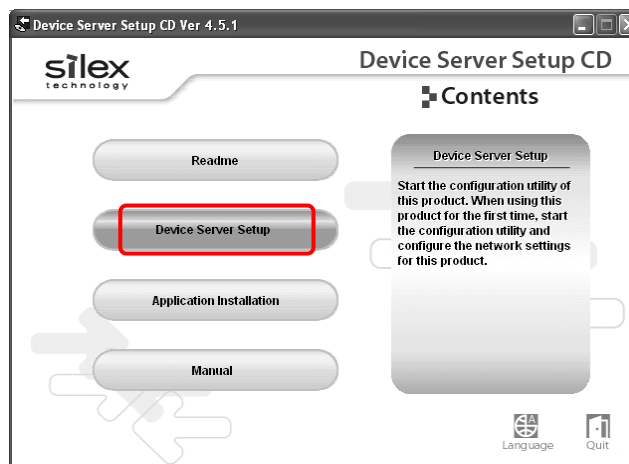

(8) Select "Wired".

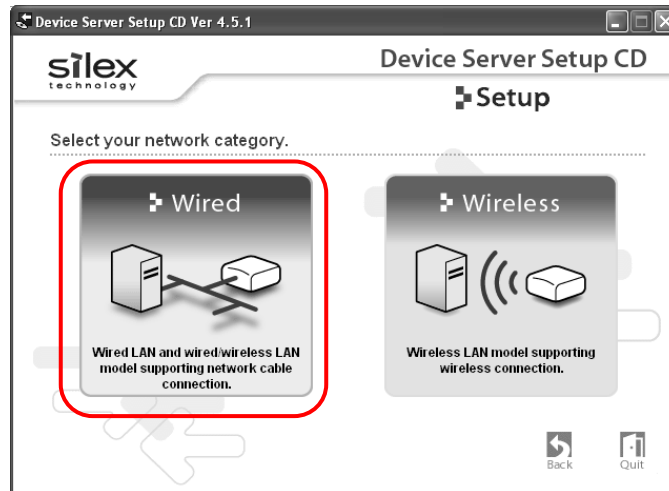

(9) Click "Yes".

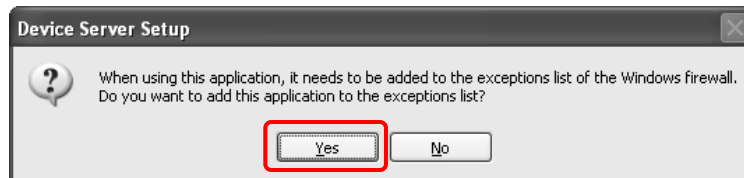

(10) Click "Next".



(11) Click "Yes".

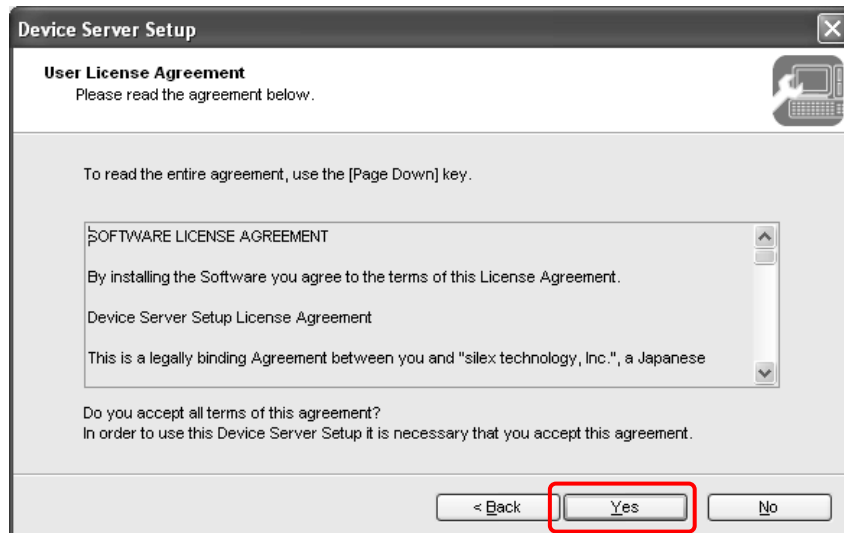

(12) After a while, SX-2000WG+ is listed in the window. Click on the entry required and click "Next".

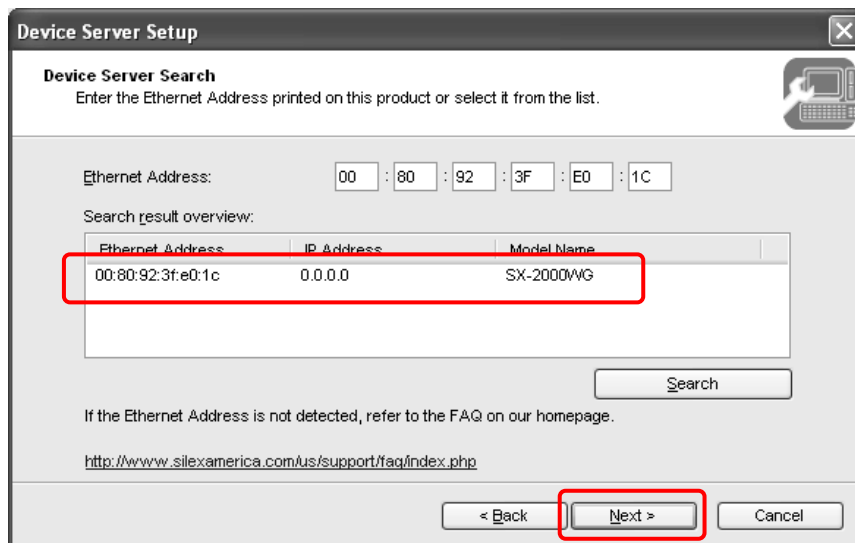

If SX-2000WG+ is not listed

1. If SX-2000WG+ is still not listed in the window, click on the "Search" button and wait for 1 minute.
2. If still not listed, please disconnect and connect the network cable, and restart the device server (Disconnect and connect the power cable). Please wait 2 minutes to configurate wireless connection.
3. If still not listed, please go back to Step (a)-(c) in Section 2(2)

- (13) Select "Assign IP Address" and input the default parameters shown below and then click "Next".

Device Server Setup

Setting TCP/IP
Setting TCP/IP will proceed.

Get IP Address Automatically
 Assign IP Address

IP Address: 192 . 168 . 0 . 1
Subnet Mask: 255 . 255 . 255 . 0
Default Gateway: 0 . 0 . 0 . 0

MEMO
If you select [Get IP Address Automatically], the DHCP server assigns an IP address to this product. If a DHCP server is not available, please manually assign an IP address.

< Back **Next >** Cancel

IP Address: 192.168.0.1
Subnet Mask: 255.255.255.0
Default Gateway: 0.0.0.0

IP Address to be used

If the same parameters are used for other network, use a different subnet address such as 192.168.1.1. If you are not sure, please ask the network administrator.

- (14) Select "SSID:GROUP" "Channel:11" and click "Detailed Config".

Device Server Setup

Wireless Setting
Setting for Wireless usage.

Select the wireless network (SSID of the access point or network device) that you wish to use.

SSID	Channel	Wireless Stand...	Wireless Mode	BSSID
GROUP	11		AdHoc	

Network Key: [] Search
Confirm Network Key: []

Skip wireless configuration **Detailed Config >>**

< Back Next > Cancel

(15) Input the default parameters shown below and click “Next”.

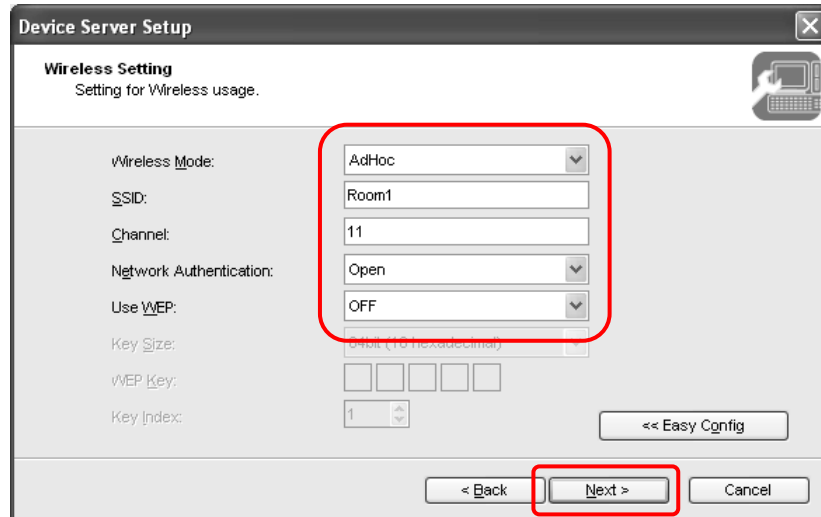

Wireless Mode: AdHoc
SSID: Arbitrary ("Room1" for this manual)
Channel: 11
Network Authentication: Open
Use WEP: OFF

SSID

If you install multiple device servers in a close range, please assign unique SSID for each device server. For example, use the room name and so on.

(16) Click “Execute”.

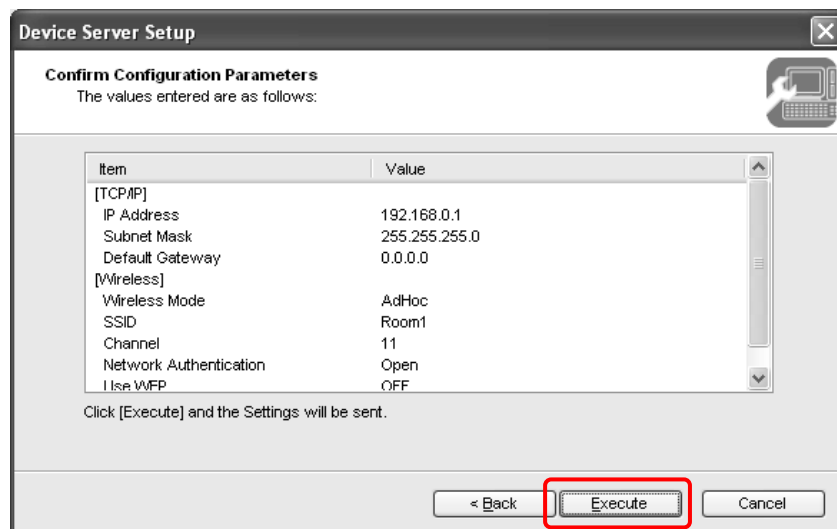

- (17) Click “Finish” and install SX Virtual Link.

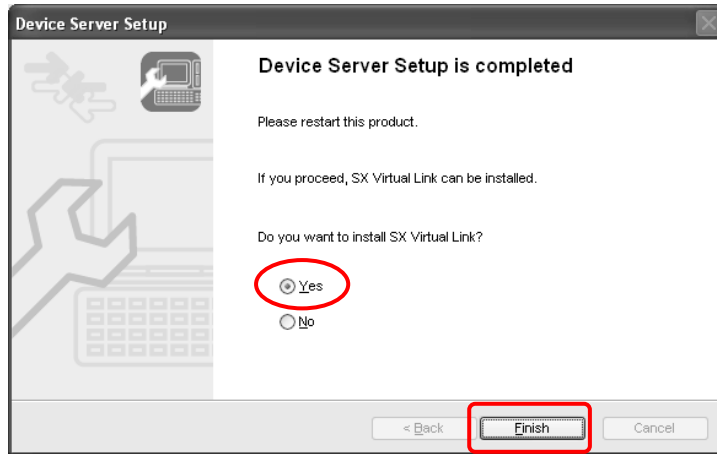

- (18) Select “English” and click “Next”. Skip here if the window does not appear.

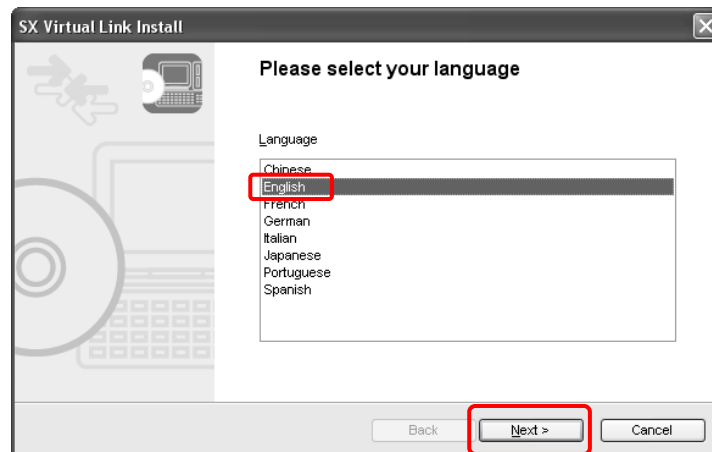

- (19) Click “Next”.



(20) Click "Yes".

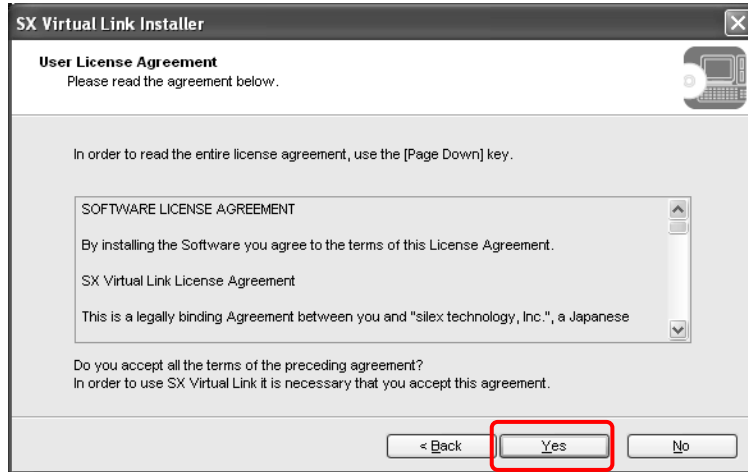

(21) Click "Next".

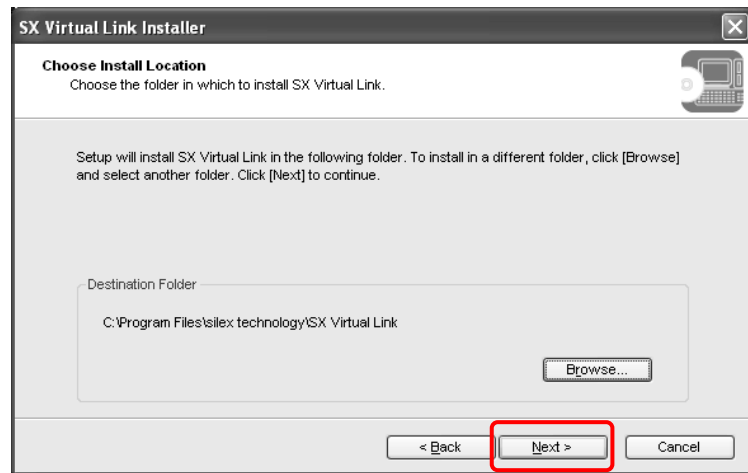

(22) Click "Next".

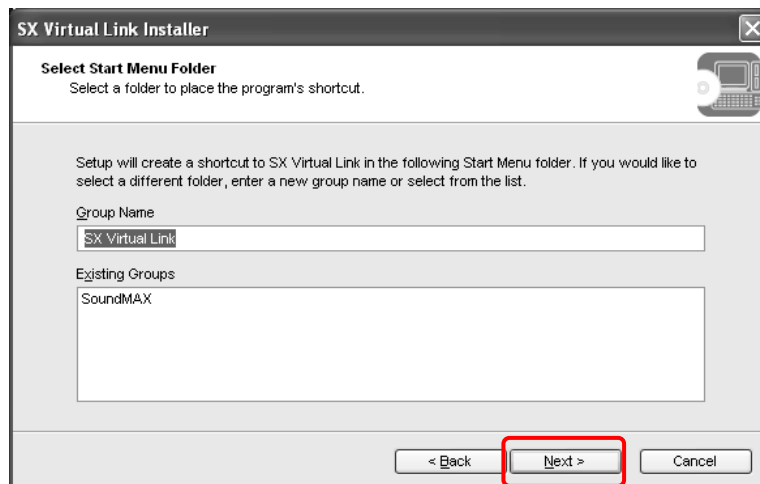

(23) Click "Start".

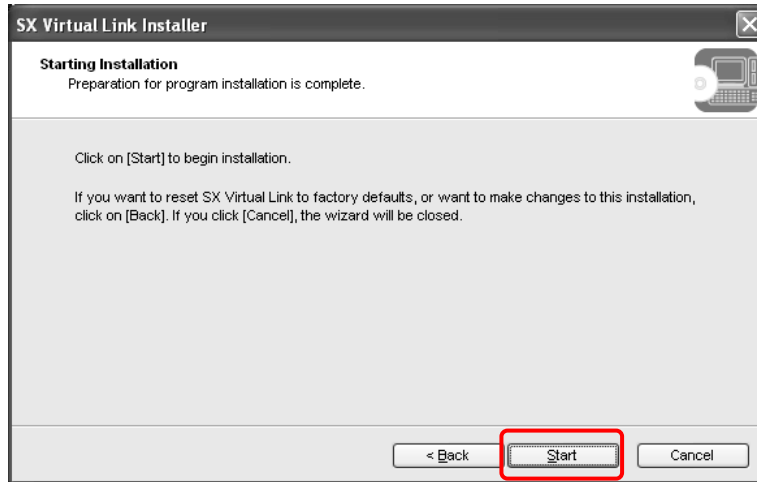

(24) Click "Yes".

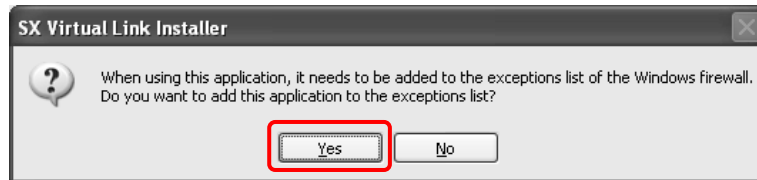

(25) Select "Do not connect" and click "Next".

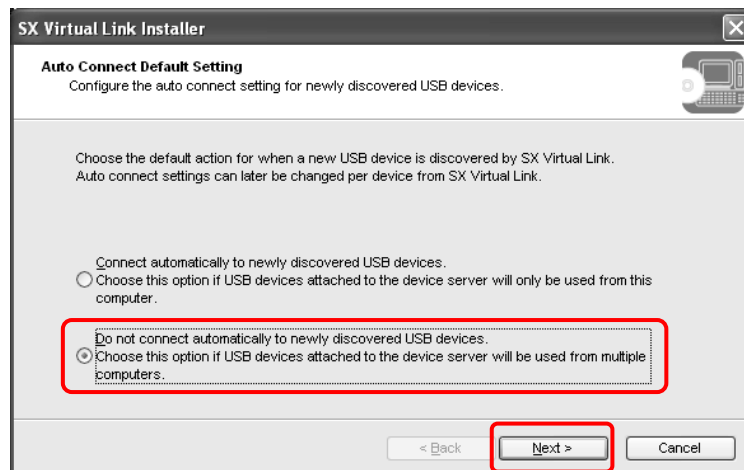

(26) Click "Finish".

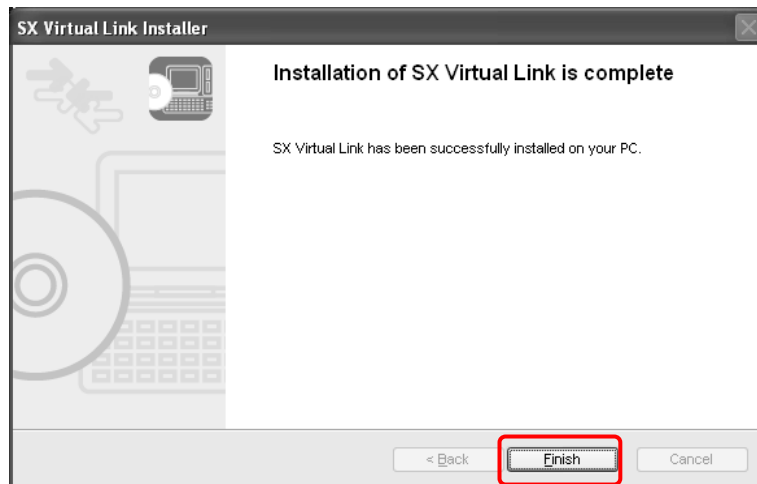

(27) Close window.

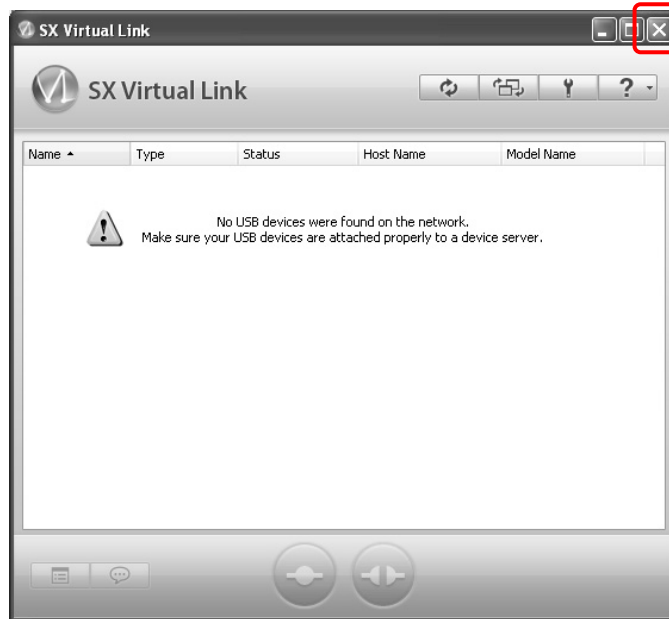

3. Planex GW-USMicro300 Detailed Setup

- (1) Unplug the network cable from SX-2000WG+, and restart SX-2000WG+ (disconnect and connect the power cable).

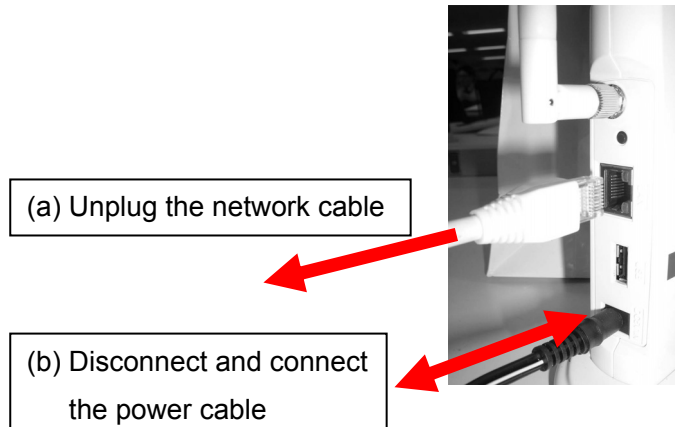

- (2) Please check if the top LED is blinking green.

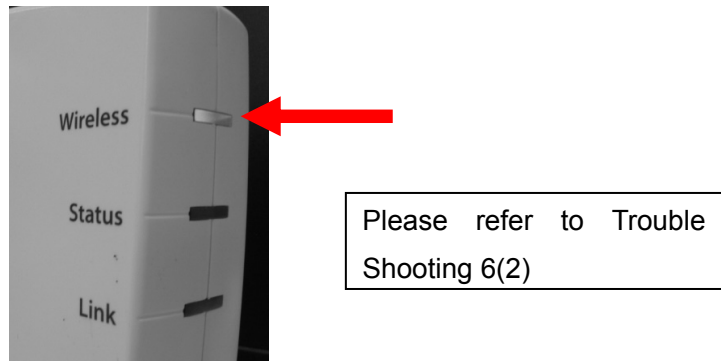

- (3) Download the latest installer from Planex web site.

URL(<http://www.planex.net/download/wireless/gw-usmicro300.htm>)

- (4) Run "Setup".

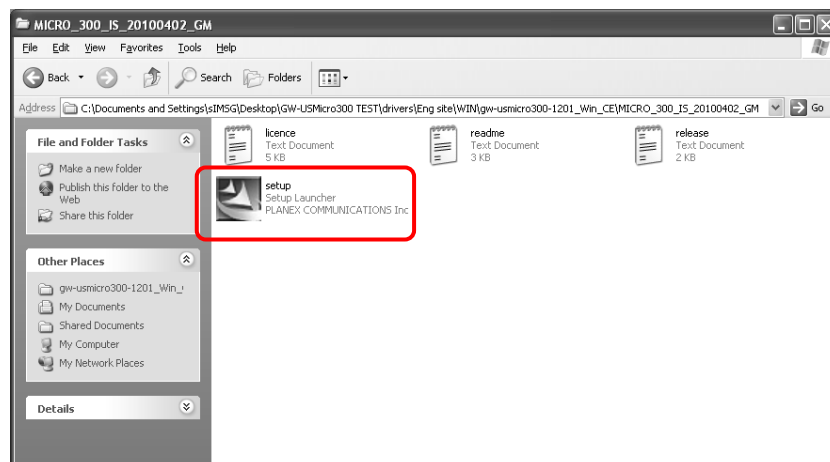

(5) Click "Run".

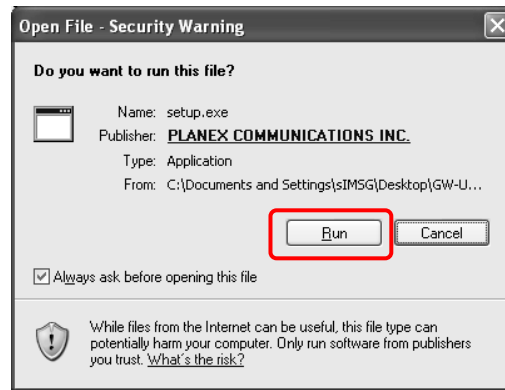

(6) Click "Next".

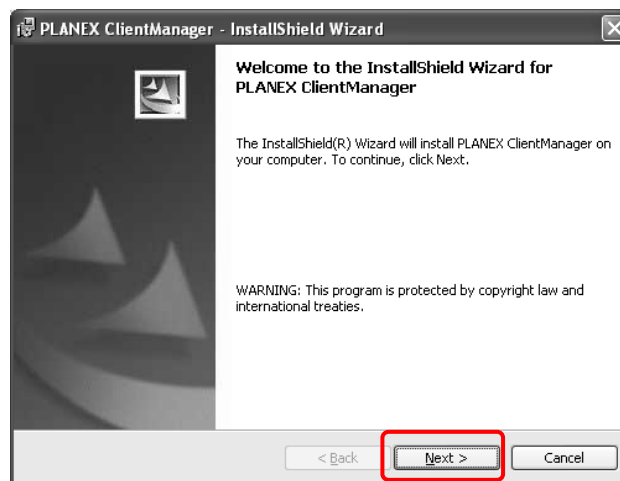

(7) Click "Install".

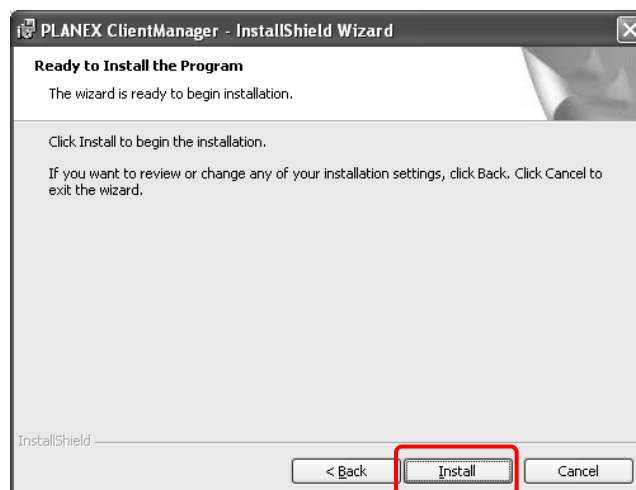

(8) Click "Finish".

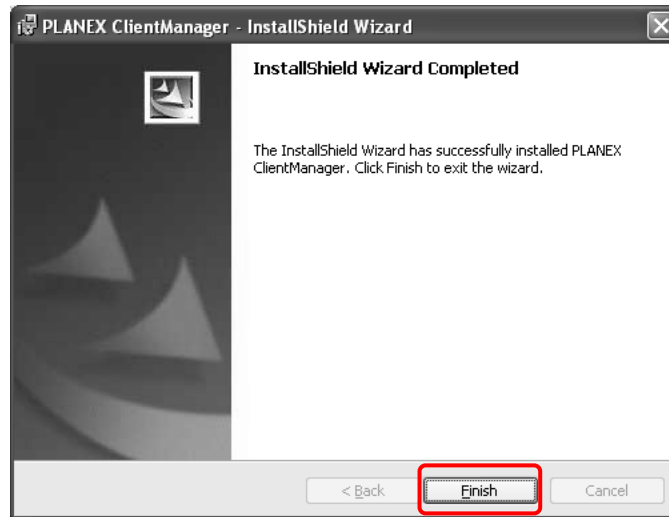

(9) Click "Connect PC to the internet".

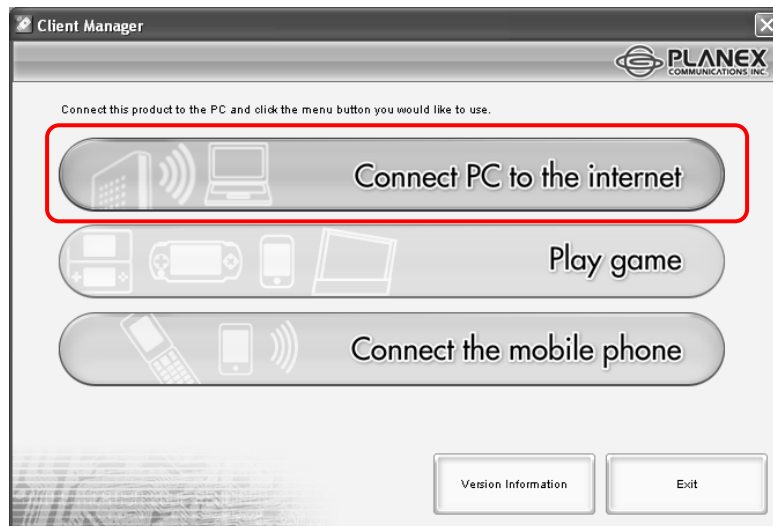

(10) Plug GW-USMicro300 into the PC and click "OK".

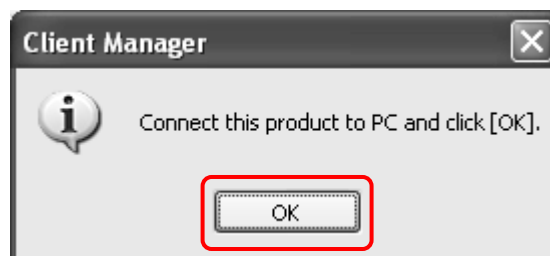

- (11) Click "Cancel". If (11) – (13) message is not displayed, skip to (14) directory.



- (12) Click "Yes".

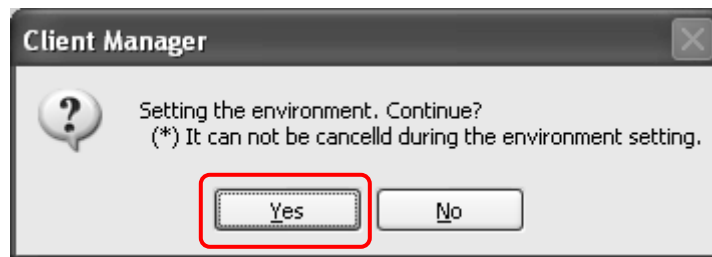

- (13) Click "Continue Anyway".

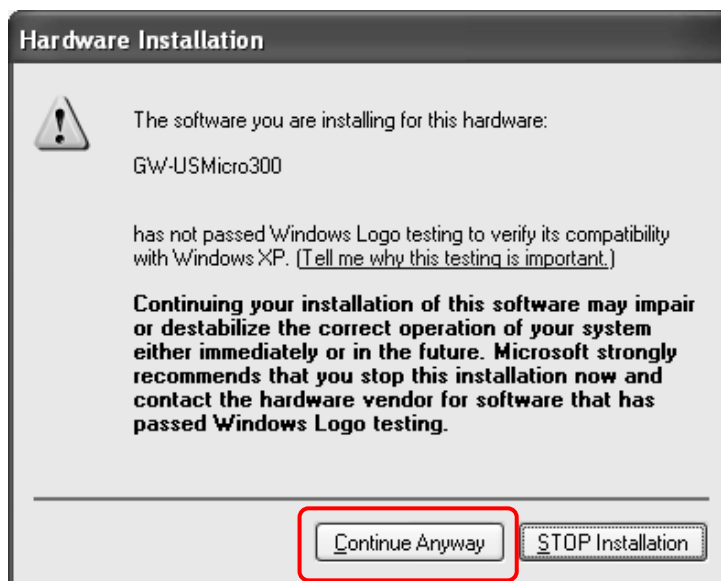

(14) Click "Cancel".

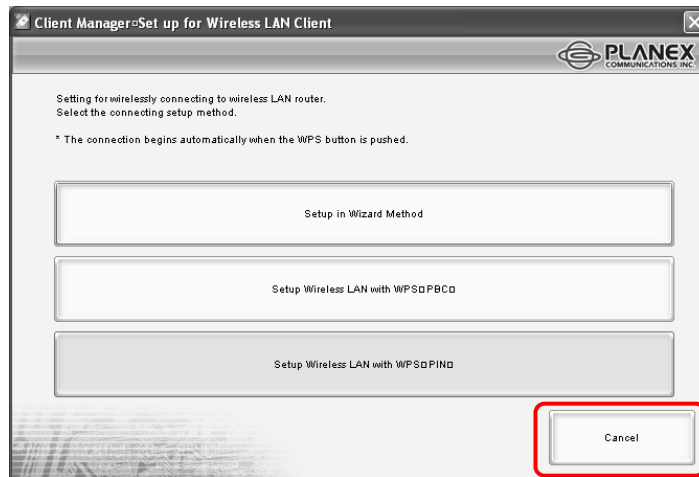

(15) Open Explorer and right click the "My Network Places", select "properties".

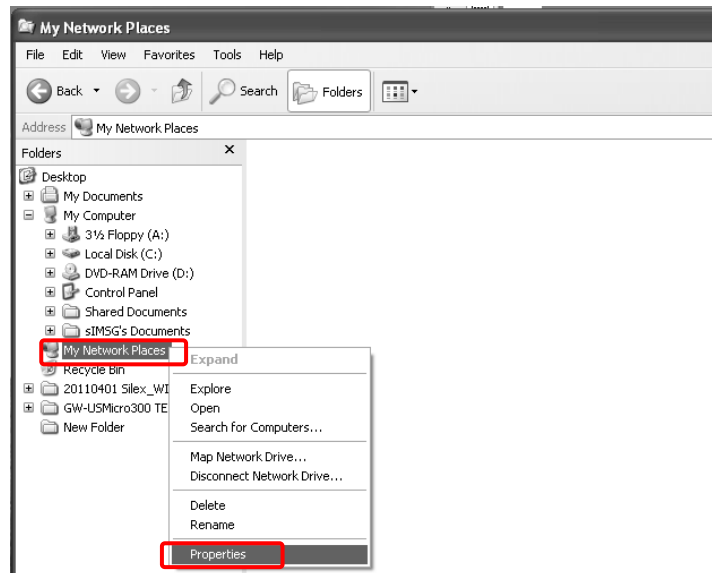

(16) Right click the "Wireless Network Connection" and select "properties".

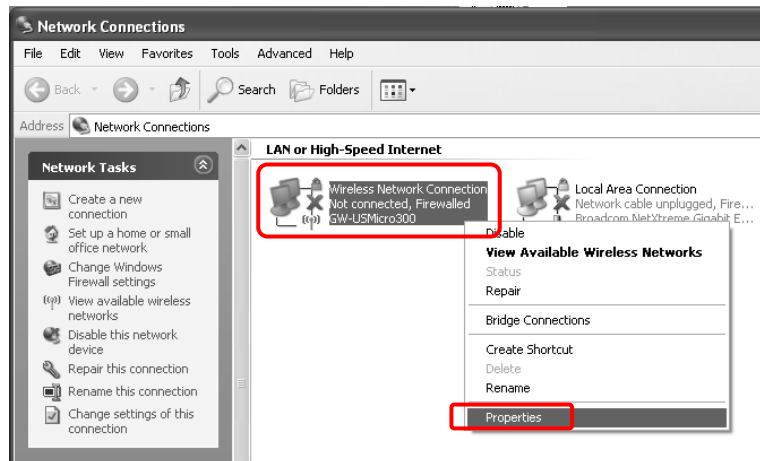

- (17) Select “Internet Protocol (TCP/IP)” and select “Properties”.

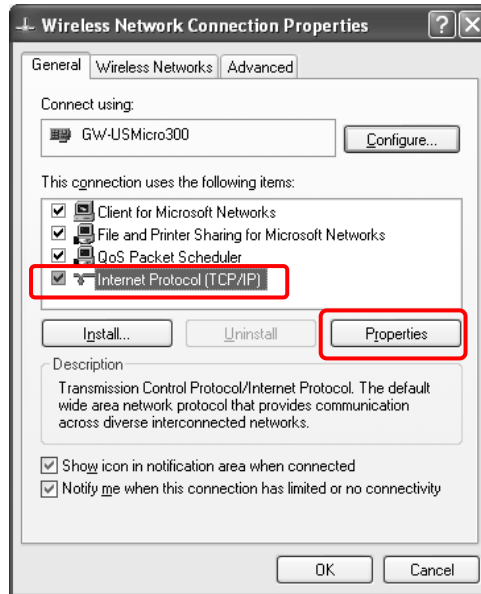

- (18) Input the default parameters and click “OK”.

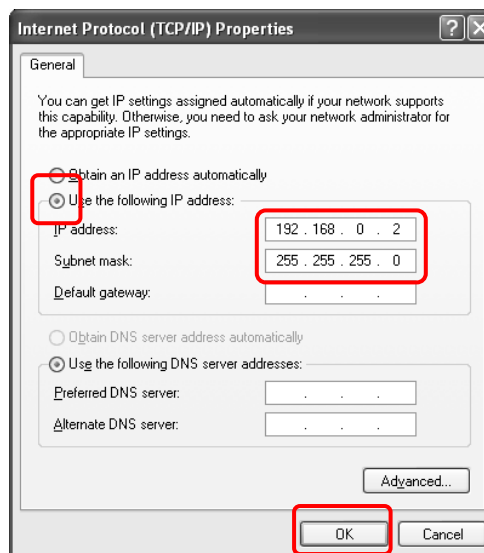

IP address: 192.168.0.2
Subnet mask: 255.255.255.0
Default gateway: Blank

IP Address to be used

If you did not use the default parameters for SX-2000WG+, please use the relevant parameters. If you are not sure, please ask the network administrator.

(19) Click "Close".

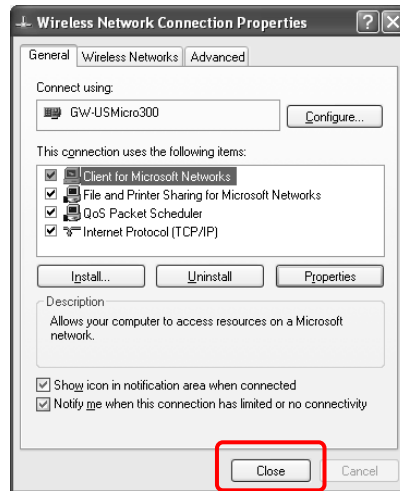

(20) Right click the "Wireless Network Connection" and select "View Available Wireless Networks".

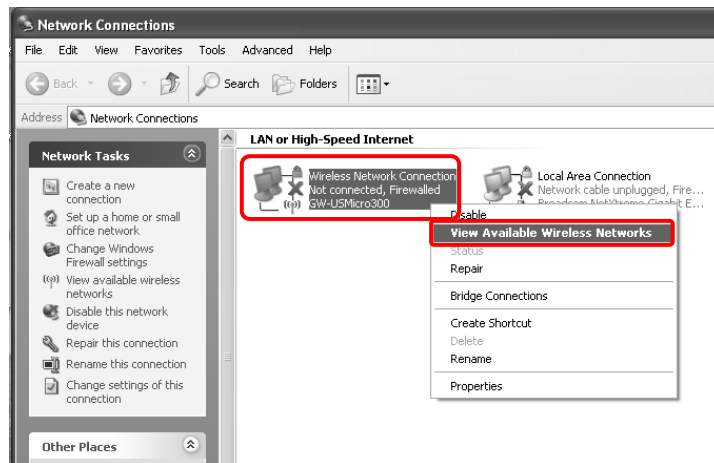

(21) Select "Room1" and Click "Connect".

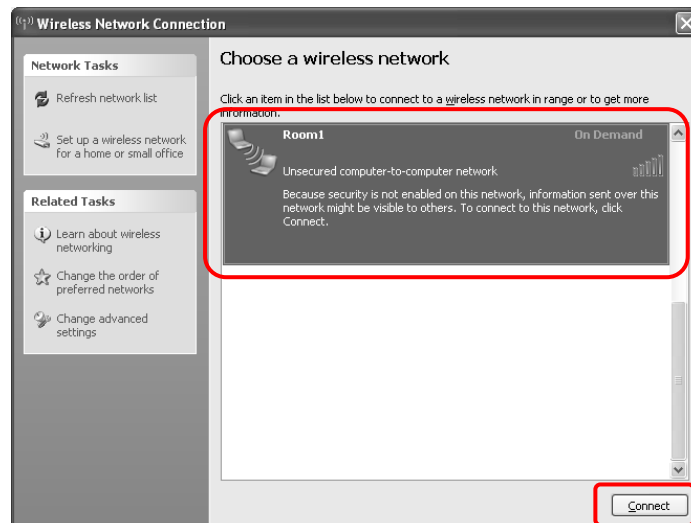

(22) Click “Connect Anyway”.

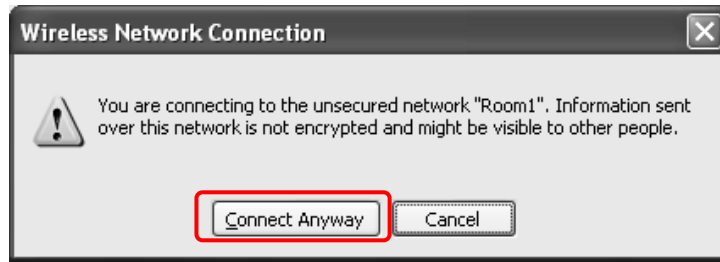

(23) Once “Connected” is shown, wireless network “Room1” is established.

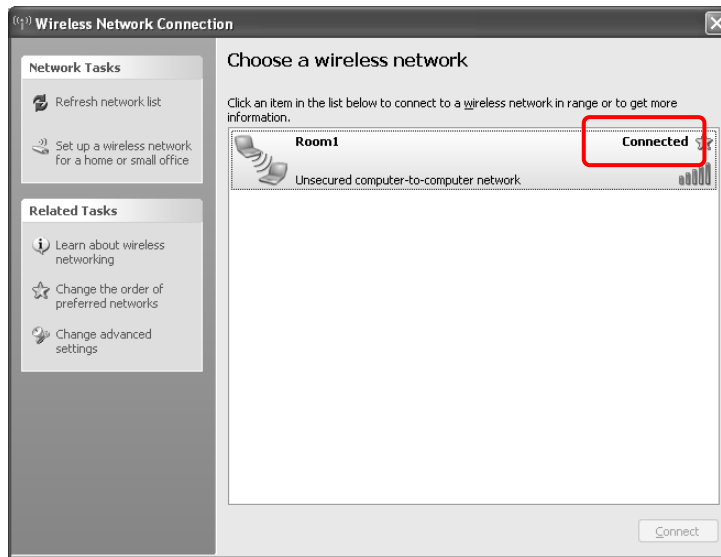

4. FX-DUO/FX-TRIO Setup

(1) Connect FX-DUO/FX-TRIO to the USB port of SX-2000WG+ .

Device Connection to SX-2000WG+

If FX-DUO/FX-TRIO is connected to SX-2000WG+, please do not use a USB hub. Connecting multiple USB devices is not supported if FX-DUO/FX-TRIO is connected.

(2) Run “Start”→”All Programs”→”SX Virtual Link”→”SX Virtual Link”.

If window does not appear, click the icon below in the task tray.



(3) Click button below.

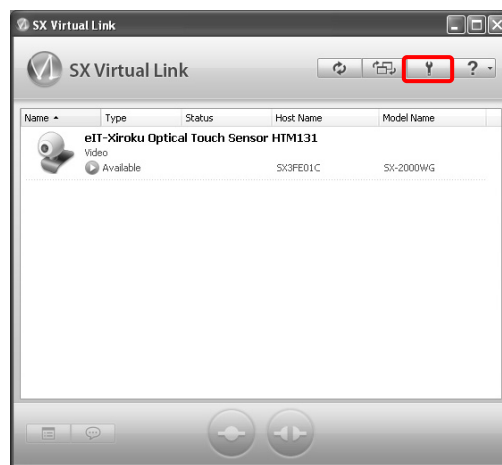

(4) Click on “Search for device servers” and check the “Enable broadcast addresses” on. Input “192.168.0.255” and select “Add” as shown below and click “OK”.

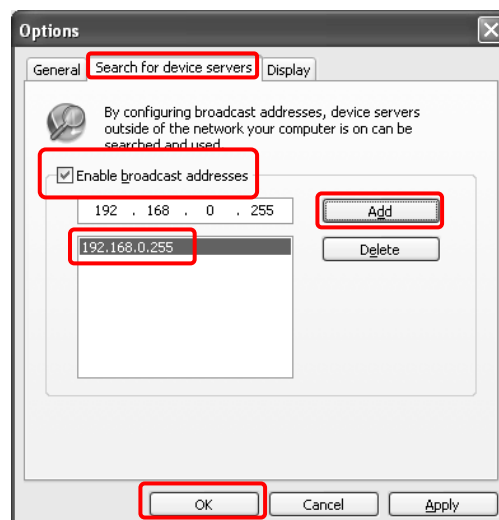

Broadcast Address to be used

If you did not use the default parameters for SX-2000WG+, please use the relevant broadcast address. If you are not sure, please ask the network administrator.

(5) Click on the USB device entry listed in the window and select button below.

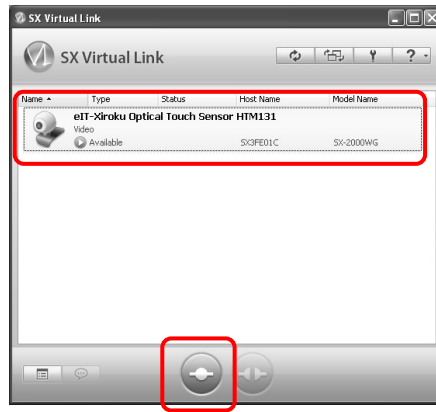

If SX-2000WG+ is not listed

If SX-2000WG+ is not listed in the window, please refer to Trouble Shooting 7(2) to make sure the device server is working and the connection is established. If the ping command does not work properly, please check the settings of SX-2000WG+ and GW-USmicro300.

(6) Window shown below appears while connecting.

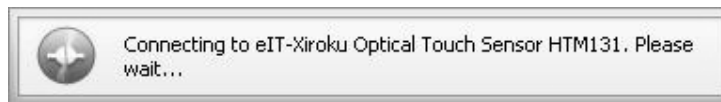

(7) Run "Start" → "All Programs" → "StarBoard Software". You can see if FX-DUO/FX-TRIO is connected by the task tray icon.



not connected



connected

5. How to reconnect

- (1) Make sure GW-USMicro300 is connected to the PC.
- (2) Run "Start" → "All Programs" → "SX Virtual Link" → "SX Virtual Link".
- (3) Click on the USB device entry listed in the window and select button below.

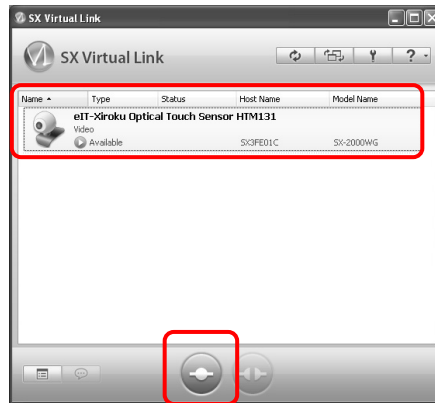

- (4) You can see if FX-DUO/FX-TRIO is connected by the task tray icon.



not connected



connected

6. Trouble Shooting

(1) SX-2000WG+ is not displayed for initial settings (wired connection)

(a) Check the LED

If SX-2000WG+ is working with the wired mode, the bottom LED is solid green.

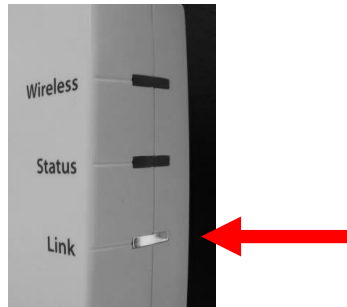

If not, please check if the hub and the cable are not faulty, and make sure the connection and restart SX-2000WG+ (disconnect and connect the power cable). If the LED is not still solid green, the unit might be faulty and contact the support for SX-2000WG+. Please refer to “Device Server Setup CD” for support center information.

(2) Connection not established (wireless connection)

(a) Check the LED

If the settings for wireless connection are configured properly, the LED is blinking green.

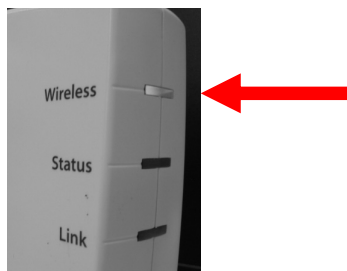

If not, please disconnect the network cable and restart the SX-2000WG+ (disconnect and connect the power cable).

If the LED is not still blinking green, please go back to Section 3 and set up again.

If still not, the unit might be faulty and contact the support for SX-2000WG+. Please refer to “Device Server Setup CD” for support center information.

(b) Ping command

Run "Start" → "All Programs" → "Accessories" → "Command Prompt" and input "ping 192.168.0.1(IP address for SX-2000WG+) and press enter key.

```
E:\WINDOWS\system32\cmd.exe
C:\>ping 192.168.0.1
Pinging 192.168.0.1 with 32 bytes of data:
Reply from 192.168.0.1: bytes=32 time=1ms TTL=255
Reply from 192.168.0.1: bytes=32 time=1ms TTL=255
Reply from 192.168.0.1: bytes=32 time=1ms TTL=255
Reply from 192.168.0.1: bytes=32 time=1ms TTL=255

Ping statistics for 192.168.0.1:
    Packets: Sent = 4, Received = 4, Lost = 0 (0% loss),
    Approximate round trip times in milli-seconds:
        Minimum = 1ms, Maximum = 1ms, Average = 1ms

C:\>
```

Network Connection Established

```
E:\WINDOWS\system32\cmd.exe
C:\>ping 192.168.0.1
Pinging 192.168.0.1 with 32 bytes of data:
Request timed out.
Request timed out.
Request timed out.
Request timed out.

Ping statistics for 192.168.0.1:
    Packets: Sent = 4, Received = 0, Lost = 4 (100% loss),

C:\>
```

Network Connection Not Established.

After trying all the trouble shooting, please contact the support for SX-2000WG+.

(3) FX-DUO/FX-TRIO can not work correctly

If FX-DUO/FX-TRIO can not work correctly, please try following recovery process.

- (a) Unplug USB cable from SX-2000WG+, then the USB device entry listed in the window will be disappeared after 30 seconds. (Status display changes “You are connected”→ “USB device not found”)



- (b) Plug USB cable to SX-2000WG+ again, and it automatically connects.

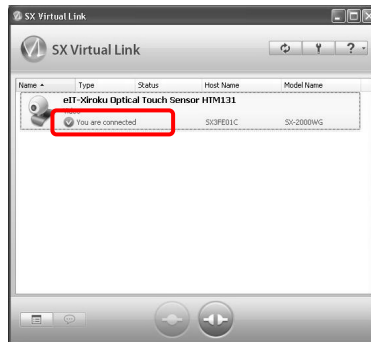

- (c) You can see if FX-DUO/FX-TRIO is connected by the task tray icon.



not connected



connected

- (d) If still have troubles, please restart the SX-2000WG+ (Disconnect and connect the power cable). Please wait 2 minutes to configurate wireless connection. Then follow section 6 to reconnect.

- (e) If still not work correctly, reboot PC.

(4) How to re-setup USB GW-USMicro300

In order to re-setup GW-USMicro300, please uninstall the driver and install it again in accordance with following instruction.

(a) Run “Setup” (GW-USMicro300 installer).

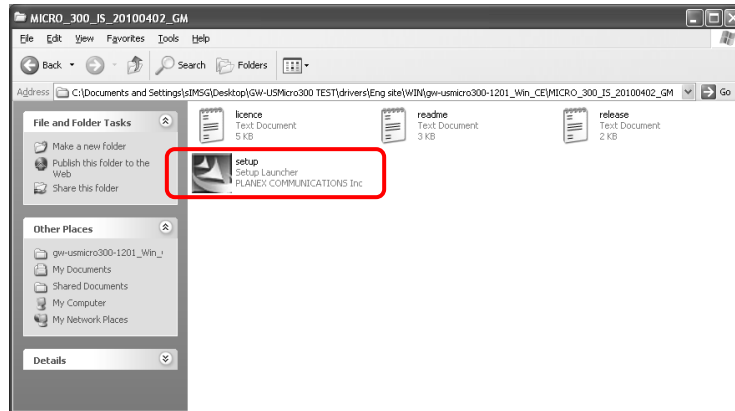

(b) Click “Run”.

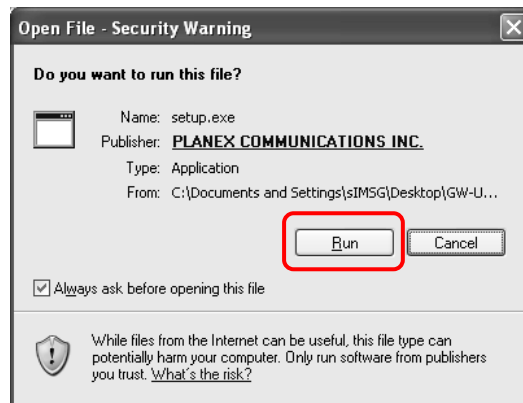

(c) Click “Next”.

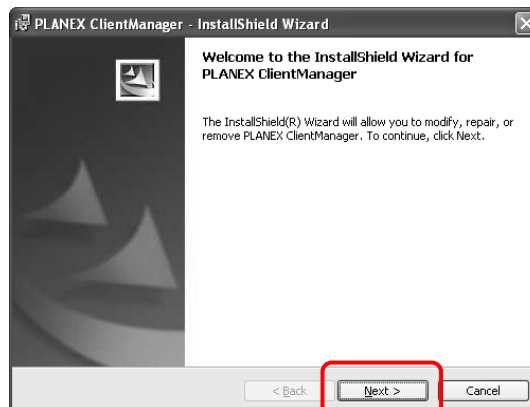

(d) Click "Remove".



(e) Click "Finish".

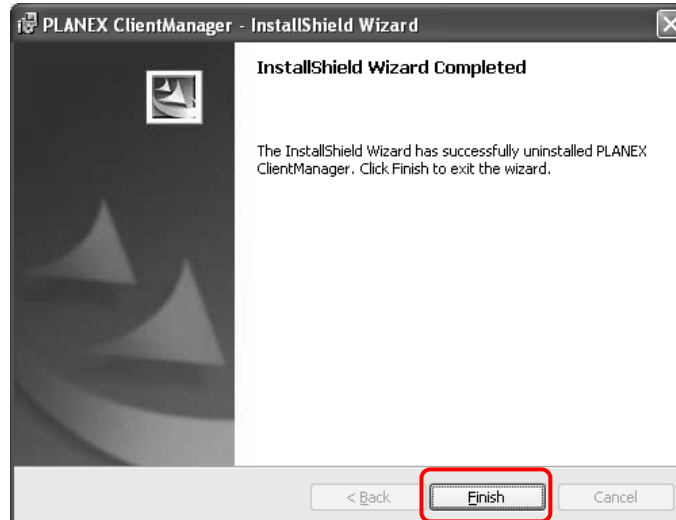

-End of file-